



**USA BRAND**

Manufacturer of Hydraulic Hoses, Fittings and Accessories

## PRODUCT LINE

### INTELLIGENT SOLUTIONS

FOR DIFFERENT APPLICATIONS



### HOSES AND FITTINGS FOR

Construction - Agricultural - Oil and Gas - Industrial  
Mining Petrochemical - Automotive



Tel: +1 786 655 7577  
Fax: +1 954 639 9622



Miami, Florida  
United States of America



[sales@axxionflex.com](mailto:sales@axxionflex.com)

[www.axxionflex.com](http://www.axxionflex.com)



Axxionflex is a specialized manufacturer of hydraulic hoses, fittings and adapters with nearly a decade of production experience. We provide premium quality products with quality assurance.

The company's operation scope involves all different areas of the hydraulic system. This includes hydraulic hoses, hose fittings, transition joints, quick connectors, pipe joints assembly equipment, test equipment, hydraulic solenoid valves, precision high-pressure seamless steel tubes and imported seal parts of various materials, pressure levels and dimension norms. The products are used in the hydraulic and fluid conveying systems in the metallurgical machinery, petroleum, mining, construction chemicals, agriculture, textile, marine vessels, aerospace, military, electronic entertainment, pharmaceutical, and food industries.

The plant is fully automated with CNC lathes and high-precision machine tools. The hydraulic fittings and hose assemblies of the company have formed a pattern of broad product ranges and large varieties.

The company has established a sound quality management system, and passed the ISO9001 international quality system certification and the internationally accepted DIN and SAE standards.

Our products have national and international quality standards.



# PRODUCT LINES



Hydraulic Hoses



Hydraulic Hoses  
Fitting and Adapters



Oil and Gas  
Drilling Products



Automotive  
Hose and Fittings



Hose Camlock  
Couplings, Fittings  
& Accessories



Industrial  
Rubber Hoses



Concrete Hose  
and Pump Parts



Valves, Pumps &  
Accessories



Hydraulic Hose and  
Tubing Processing  
Machines

**DOWNLOAD**  
OUR CATALOGS



[www.axxionflex.com](http://www.axxionflex.com)



 /AxxionFlex

**AF** **AXXION FLEX**<sup>®</sup>

**AF1SN**

EN 853 1SN / SAE 100 R1S  
ISO 1436-1 1SN

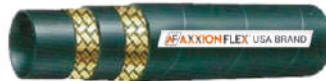
**AF2SN**

EN 853 2SN / SAE 100 R2S  
ISO 1436-1 2SN

**AF4SP**

EN 856 4SP  
ISO 3862-1 4SP

**AFR3**

SAE 100 R3

**AFR6**

SAE 100 R6

**AFR7**

SAE 100 R7  
EN 855 R7

**AFR8**

SAE 100 R8  
EN 855 R8

**AFR4**

SAE 100 R4

**AFR5**

SAE 100 R5

**AF1SC**

EN 857 1SC  
ISO 1436-1 1SC

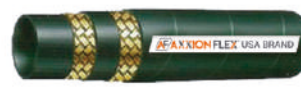
**AF2SC**

EN 857 2SC / ISO 1436-1 2SC  
SAE 100 R16

**AFR17**

SAE 100 R17  
ISO 1237-1 R17

**AFR12**

SAE 100 R12 / EN 856 R12  
ISO 3862-1 R12

**AFR13**

SAE 100 R13 / EN 856 R13  
ISO 3862-1 R13

**AF4SH**

EN 856 4SH  
ISO 3862-1 4SH

**AFJW1B / 2B**

AFW 2C / 2C  
JET WASH HOSE

**AF2SNCW**

EN 853 2SN / SAE 100 R2S  
ISO 1436-1 2SN  
HIGH PERFORMANCE

**AFR15CW**

SAE 100 R15 / EN 856 R15  
ISO 3862-1 R15  
HIGH PERFORMANCE

**AFR3CW**

SAE 100 R3  
HIGH PERFORMANCE

**AFST170**

STEAM HOSE



**FERRULES**



**HOSE FITTINGS**



**BSP ADAPTERS**



**METRIC TUBE ADAPTERS**



**METRIC ADAPTERS**



**SAE ADAPTERS**

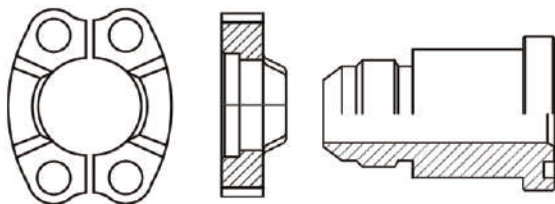

**FLANGE ADAPTERS**



**QUICK COUPLING & OTHERS**



HIGH STRENGTH DRILLING HOSE



WELL CONTROL PROFESSIONAL TUBE BOP CONTROL LINE



FLEXIBLE CHOKE KILL LINE



FLEXIBLE METAL HOSE SERIES



LARGE DIAMETER DREDGING RUBBER HOSE



MUD SUCTION & DISCHARGE RUBBER HOSE



EXTRA-LONG CONTROL CABLE

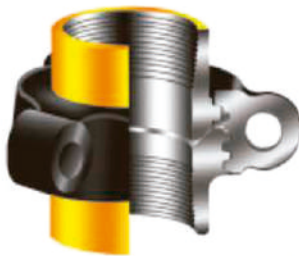

HAMMER UNION



QUICK ASSEMBLY FOR SOLID CONTROL SYSTEM



HIGH STRENGTH MOVEMENT PIPE BEND



HIGH PRESSURE T-CONNECTOR FLANGES AND CROSS JOINT, BEND, SIZE HEAD



UNIVERSAL SELF SEALING PIPE JOINT



BOP RUBBER CORE AND ASSEMBLY



**AIR CONDITIONING HOSE  
SAE J2064 TYPE C**



**AIR CONDITIONING HOSE  
SAE J2064 TYPE E**



**SAE J188  
POWER STEERING  
HOSE**



**AIR CONDITIONING  
HOSE FITTING**



**SAE J1401  
BRAKE HOSE**

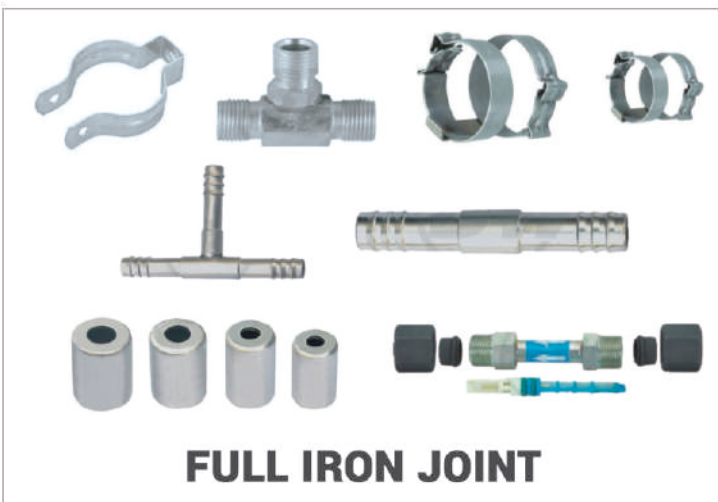

**FULL IRON JOINT**



**BLOCK/FLANGE SERIES**

# HOSE CAMLOCK COUPLINGS, FITTINGS & ACCESSORIES



**CAM & GROOVE**



**GUILLEMIN**



**DIN STANDARD**



**QUICK CONNECT**



**THREADED & UNTHREADED**



**SUCTION & DELIVERY**



**HOSE CLAMP SYSTEMS**



**STORZ COUPLING**



**MISCELLANEOUS**



 <p><b>ABRASION</b> AIR SEEDER HOSE (HARDWALL) MANDREL</p>	 <p><b>ABRASION</b> BULK MATERIALS DISCHARGE HOSE MANDREL</p>	 <p><b>ABRASION</b> BULK MATERIALS SUCTION DISCHARGE MANDREL</p>	 <p><b>ABRASION</b> SANDBLAST HOSE MANDREL</p>
 <p><b>ABRASION</b> INDUSTRIAL VACUUM HOSE MANDREL</p>	 <p><b>AIR</b> AIR HOSE EXTRUSION</p>	 <p><b>AIR</b> HOT AIR HOSE EXTRUSION</p>	 <p><b>AIR</b> COMPRESSED AIR HOSE MANDREL</p>
 <p><b>AUTOMOBILE</b> AIR BRAKE HOSE EXTRUSION</p>	 <p><b>AUTOMOBILE</b> CAR HEATER HOSE EXTRUSION</p>	 <p><b>AUTOMOBILE</b> RADIATOR HOSE MANDREL</p>	 <p><b>CHEMICAL</b> CHEMICAL DISCHARGE HOSE MANDREL</p>
 <p><b>CHEMICAL</b> CHEMICAL SUCTION AND DISCHARGE HOSE MANDREL</p>	 <p><b>CHEMICAL</b> UHMWPE CHEMICAL DISCHARGE HOSE MANDREL</p>	 <p><b>CHEMICAL</b> UHMWPE CHEMICAL SUCTION AND DISCHARGE HOSE MANDREL</p>	 <p><b>CHEMICAL</b> XLPE CHEMICAL DISCHARGE HOSE MANDREL</p>
 <p><b>CHEMICAL</b> XLPE CHEMICAL SUCTION AND DISCHARGE HOSE MANDREL</p>	 <p><b>FOOD GRADE</b> FOOD DISCHARGE (FOR FATTY FOODS) MANDREL</p>	 <p><b>FOOD GRADE</b> FOOD SUCTION AND DISCHARGE HOSE (FOR FATTY FOODS) MANDREL</p>	 <p><b>FOOD GRADE</b> FOOD DISCHARGE HOSE (NON-FATTY FOODS) MANDREL</p>
 <p><b>FOOD GRADE</b> FOOD SUCTION AND DISCHARGE HOSE (NOT-FATTY FOODS) MANDREL</p>	 <p><b>MARINE</b> MARINE FUEL HOSE EXTRUSION</p>	 <p><b>MARINE</b> MARINE FUEL HOSE (HARDWALL) MANDREL</p>	 <p><b>MARINE</b> MARINE WET EXHAUST HOSE (HARDWALL) MANDREL</p>

 <p><b>MARINE</b> MARINE WET EXHAUST HOSE (HARDWALL) MANDREL</p>	 <p><b>MISCELLANEOUS</b> FREON GAS HOSE (HARDWALL) EXTRUSION</p>	 <p><b>MISCELLANEOUS</b> MULTIPURPOSE HOSE MANDREL</p>	 <p><b>MISCELLANEOUS</b> FRAS AIR / WATER HOSE MANDREL</p>
 <p><b>MISCELLANEOUS</b> PROTECTIVE COVER HOSE MANDREL</p>	 <p><b>PETROLEUM / OIL</b> LOW PRESSURE TEXTILE BRAILED HOSE EXTRUSION</p>	 <p><b>PETROLEUM / OIL</b> FUEL / OIL HOSE EXTRUSION</p>	 <p><b>PETROLEUM / OIL</b> FUEL / OIL DISCHARGE HOSE MANDREL</p>
 <p><b>PETROLEUM / OIL</b> FUEL / OIL SUCTION AND DISCHARGE HOSE MANDREL</p>	 <p><b>PETROLEUM / OIL</b> TANK TRUCK HOSE MANDREL</p>	 <p><b>PETROLEUM / OIL</b> LOW TEMPERATURE TANK TRUCK HOSE MANDREL</p>	 <p><b>PETROLEUM / OIL</b> DOCK HOSE MANDREL</p>
 <p><b>PETROLEUM / OIL</b> OIL RETURN HOSE (HARDWALL) MANDREL</p>	 <p><b>WATER</b> FIRE FIGHTING HOSE EXTRUSION</p>	 <p><b>WATER</b> WASHDOWN HOSE EXTRUSION</p>	 <p><b>WATER</b> WATER HOSE EXTRUSION</p>
 <p><b>WATER</b> WATER DISCHARGE HOSE MANDREL</p>	 <p><b>WATER</b> WATER SUCTION AND DISCHARGE HOSE MANDREL</p>	 <p><b>WATER</b> LAY FLAT WATER DISCHARGE HOSE MANDREL</p>	 <p><b>WELDING</b> LPG HOSE EXTRUSION</p>
 <p><b>WELDING</b> SINGLE LINE WELDING HOSE EXTRUSION</p>	 <p><b>WELDING</b> TWIN LINE WELDING HOSE EXTRUSION</p>		



**KHB(BKH), KHM(MKH)  
SERIES HIGH PRESSURE BALL VALVE**



**VH3V SERIES TWO-POSITION  
THREE-WAY HIGH PRESSURE BALL VALVE**



**KH4 4 WAY BALL VALVE**

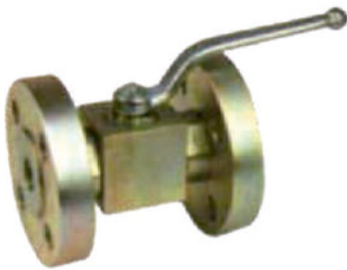

**KHB(KHMF)SERIES FLANGE  
BALL VALVE**



**BKH,MKH SERIES HIGH  
PRESSURE BALL VALVE**

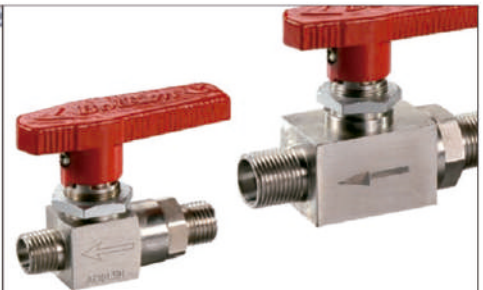

**BME SERIES HIGH PRESSURE  
BALL VALVE**



**BEH-SAE SERIES FLANGE HIGH  
PRESSURE BALL VALVE**



**KHB BALL VALVE WITH  
PNEUMATIC ACTUATORS**



**1PC TYPE BALL VALVE**



2PC TYPE BALL VALVE



2PC THREAD END BALL VALVE

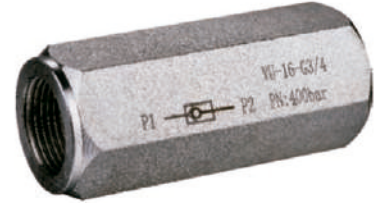

VU SERIES CHECK VALVE



STB THROTTLE VALVE



VRFU TUBULAR THROTTLE CHECK VALVE



JZF DISH TYPE LOW-PRESSURE STOP VALVE



BLV-VMS-12/31.5 SCHEDULE CONTROL VALVE



SD MULTIPLE DIRECTIONAL CONTROL VALVE



DF8-02 CHECK VALVES



CRIMPING CRM20M



CRIMPING CRM20P



CRIMPING MACHINE 2"



HOSE CUTTING CUT125



HOSE CUTTING CUT225



HOSE CUTTING CUT535P



HOSE CUTTING CUT750P



BENDING EMB642



FILTRO FILTER

HOSE REEL



HS6B



MARKER

MARK200



BENDING

MBM618



METER COUNTER

ROL102



ROLLER

ROL110



SKIVING

SKM10

WELDING



WELD80



**CONCRETE  
RUBBER HOSE**



**PISTON SHOW**



**RUBBER RING**



**CLAMP COUPLING**

## 1. How To Measure Assembly

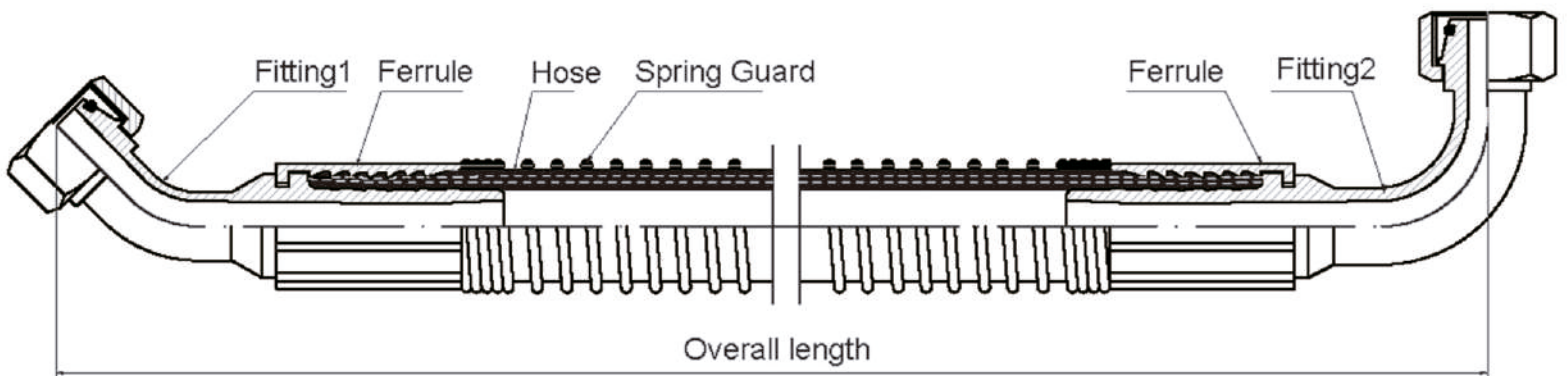

## 2. How To Measure Assembly

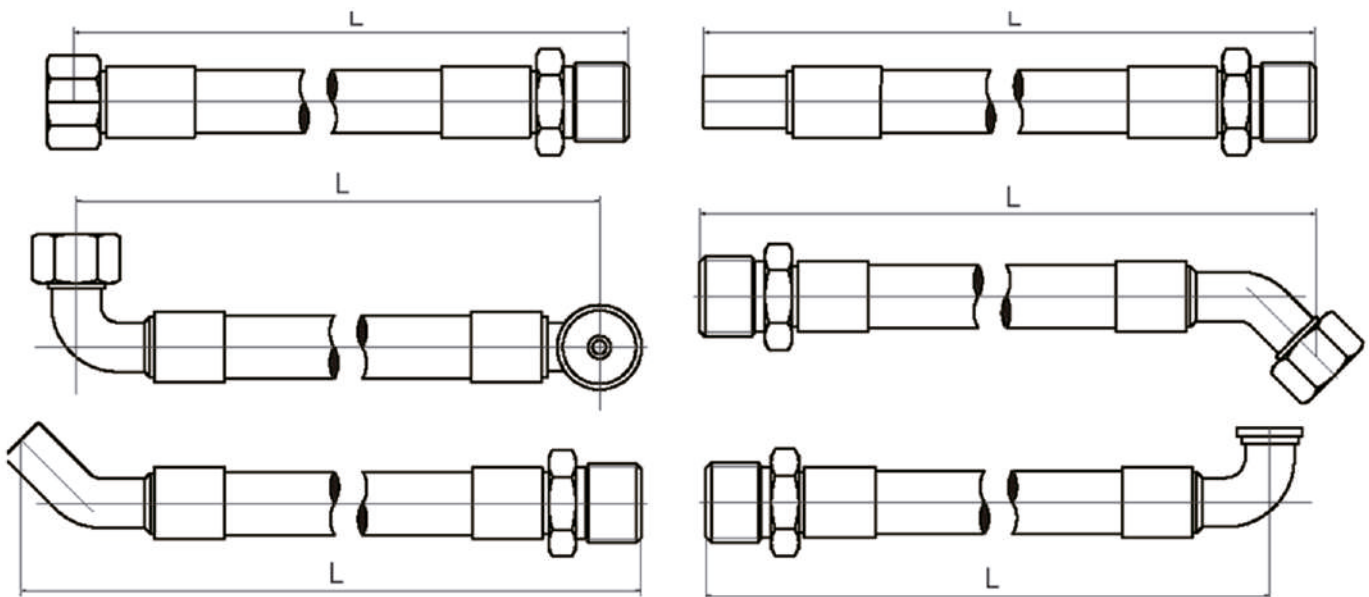



## 3. Direction Angle Of Assembly

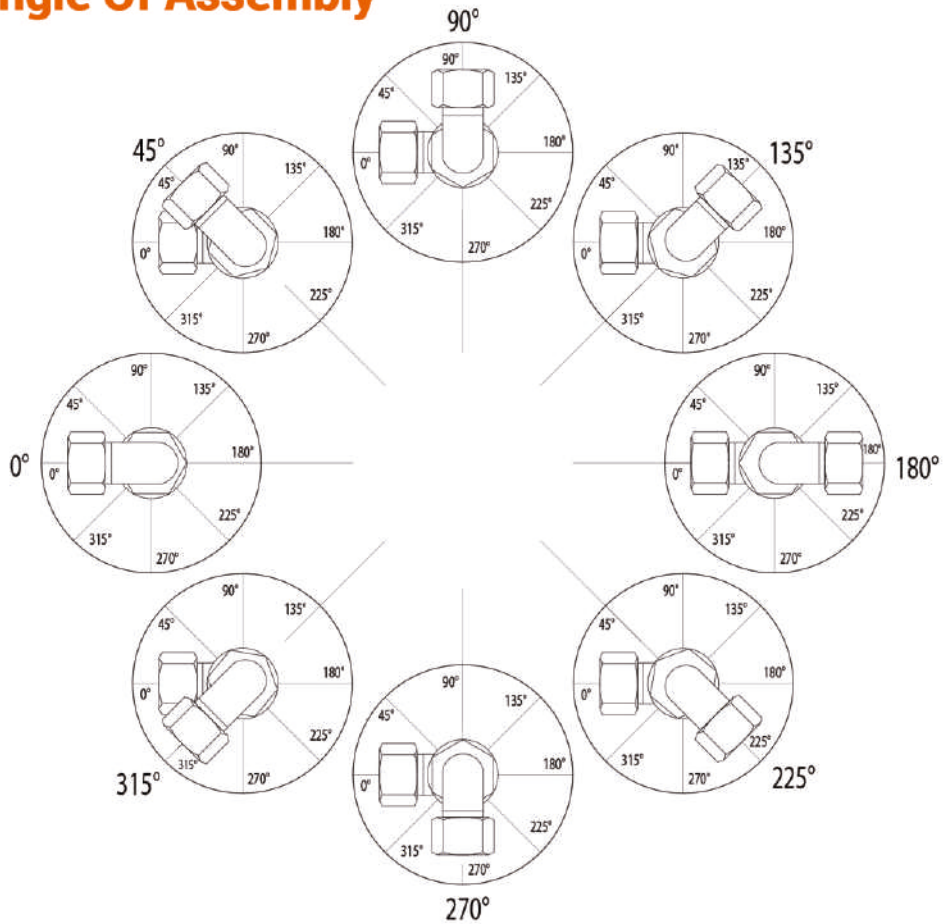

## 4. How To Measure Displacement Assembly



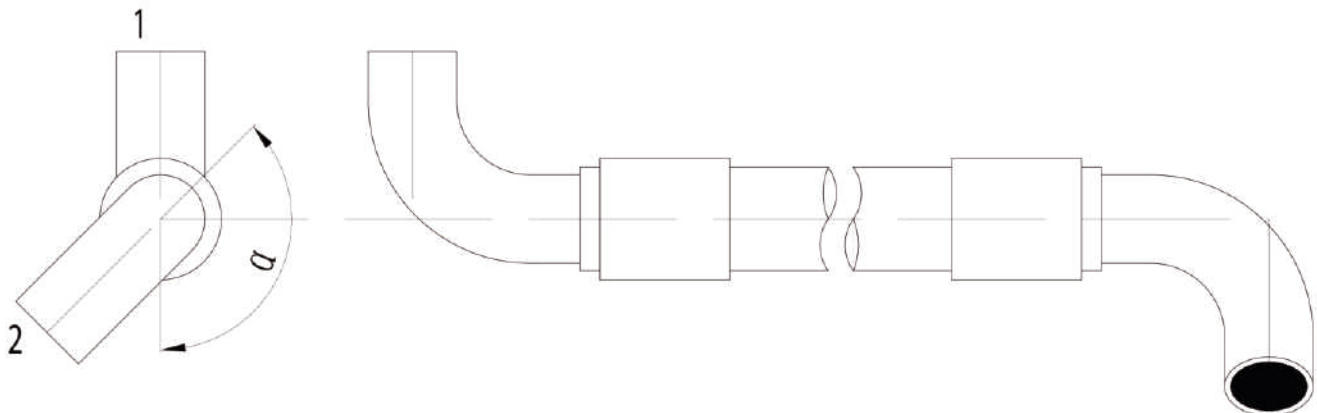

Specified only if two elbow fittings are used. To measure the displacement angle of a hose assembly, point one end of coupling "1" to a vertical position upward. The angle can be measured from the centerline of coupling "1" in a clockwise direction to the centerline of coupling "2". As shown:





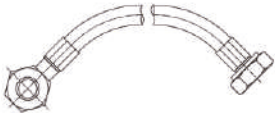

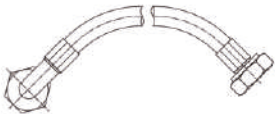





### Natural Bending Direction

Hoses are packed in bundle. So the hose is difficult to draw to straight when it is assembled. When one end fitting of the assembly is elbow, a natural bending exists. Set hose natural putting plane as horizontal plane.

When one fitting is elbow, the other fitting is straight, as shown:

	DCW	DCW		DSS	DSS
	DCN	DCN		DSX	DSX

When two fittings of the assembly are both elbow, as shown:

	SSX	SSX		SYC2	SYC2
	SSS	SSS		YNES	YNES
	SSY	SSY		YWES	YWES
	STC	STC		YNEX	YNEX
	SYC1	SYC1		YWEX	YWEX



Concrete Hose and Pump Parts



Hydraulic Hoses



Hydraulic Hoses Fitting and Adapters



Oil and Gas Drilling Products



Automotive Hose and Fittings



Hose Camlock  
Couplings, Fittings & Accessories



Industrial Rubber Hoses



Valves, Pumps & Accessories



Hydraulic Hose and Tubing  
Processing Machines





USA BRAND

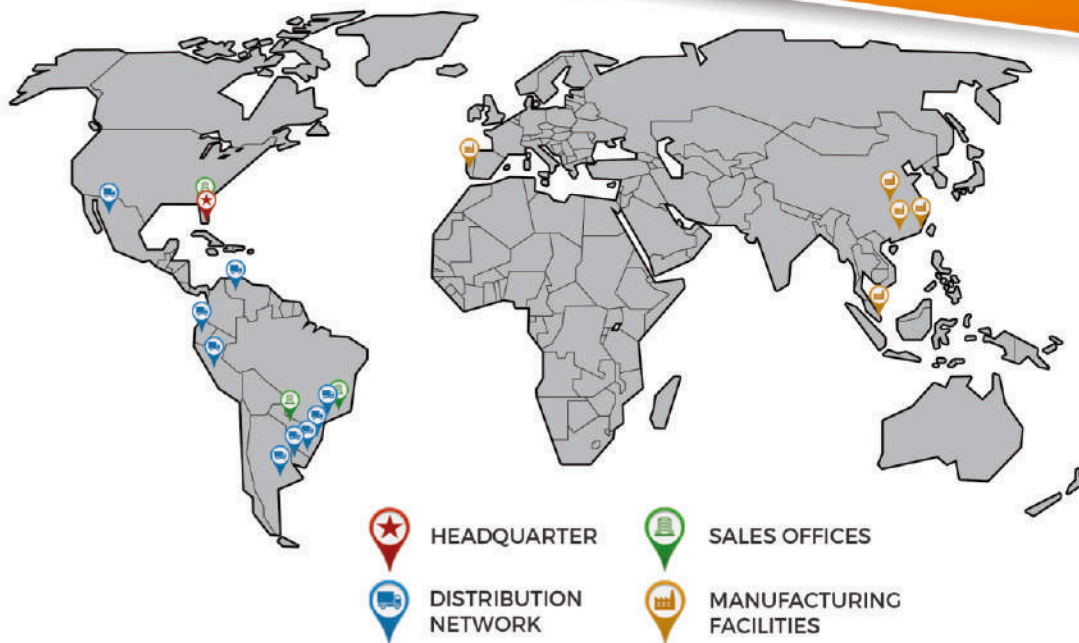

**UNITED STATES**

HEAD OFFICE AND GLOBAL SALES  
Telephone: +1 786 655 7577  
Email: sales@axxionflex.com

**BRAZIL**

DISTRIBUTION CENTER AND SALES OFFICE CISER  
Cachoeira, 70, Centro, Joinville  
Santa Catarina, Brasil  
CEP: 89205-070  
Telephone: +55 (47) 3441 3499  
SALES TELEVENDAS: 0800-147 4500  
Fax: +55 (47) 3441 3800  
E-mail: contato@ciser.com.br

**ARGENTINA - URUGUAY- BOLIVIA**

DISTRIBUTION CENTER AND SALES OFFICE  
Mr. Adalberto Silveira  
Telephone: +55(47)3441 3636  
Telephone: +55(47)3441 3510  
Email: exporta@ciser.com.br

**PERU**

DISTRIBUTION CENTER AND SALES OFFICE CISER PERU  
Mr. Vandrigo L. Cachoeira  
Jr Fernando Wiese #502  
Cercado de Lima - Peru  
Telephone: + 51 1 715 0033  
Mobile: +51 981585150  
Email: vandrigo.cachoeira@ciser.com.pe

**PARAGUAY**

SALES OFFICE  
Mr. Delcio Fischer  
Calle Dr Camacho Duré  
Asunción Paraguay  
Telephone: +595 981456409  
Email: delciofischer@gmail.com